

INSTALLATION AND USER MANUAL FOR THE AB-Q-M125 AUTO BIAS MODULE

Introduction:

This module has been designed to maintain a constant bias voltage through both tube branches in the output stage of your VTA M-125 mono block.

The bias is kept at a constant level on the output tubes, irrespective of the signal level.

Benefits:

The advantage of using the AB-Q-M125 module is that it will extend output tube life, in a lot of cases it will also improve the sound and last but not least, you will never have to worry about adjusting the bias again.

- Instead of a pair of output tubes being biased together, now all four output tubes are individually biased for greater control and stability
- No need to keep an eye on and/or adjust the bias of the output tubes
- Significant extension of the output tubes life
- Bias is not influenced by the input signal
- Undistorted and improved sound for a great listening experience
- Reduction in hum and noise level of the amp
- No maintenance or additional adjustments are required after the initial setup
- Improved overall operation of the amp due to the reduction in the danger of a tube red plating
- The AB-Q-M125 ensures that bias is kept at the pre-set value (see Initial Setup) even as the tubes age
- The AB-Q-M125 comes with a soft start feature, which slowly brings up bias to each output tube

Quick Overview:

The AB-Q-M125 module has four **blue** LED's, one for each output tube, which when lit, indicate that bias is at the correct level and that all is good with each tube.

Should any of these **blue** LED's go out or not go on after power up, means that there is an issue with that given output tube and that the tube in question needs to be immediately replaced.

When the amp is powered up, at first a **red** LED will be on, indicating that there is power to the AB-Q-M125 module. The **red** LED will go out after about 20s.

After a further delay of between 40-50s, each of the **blue** LED's should come on indicating that the bias is now set and stable for each output tube. The amp is now ready to use.

Preparing your M-125 for the AB-Q-M125 module installation:

It is best that you remove the M-125 driver pcb, as this will make the preparation much easier for you. You will also need to remove some wires and the original 10 OHM bias resistors, please refer to the following photo.

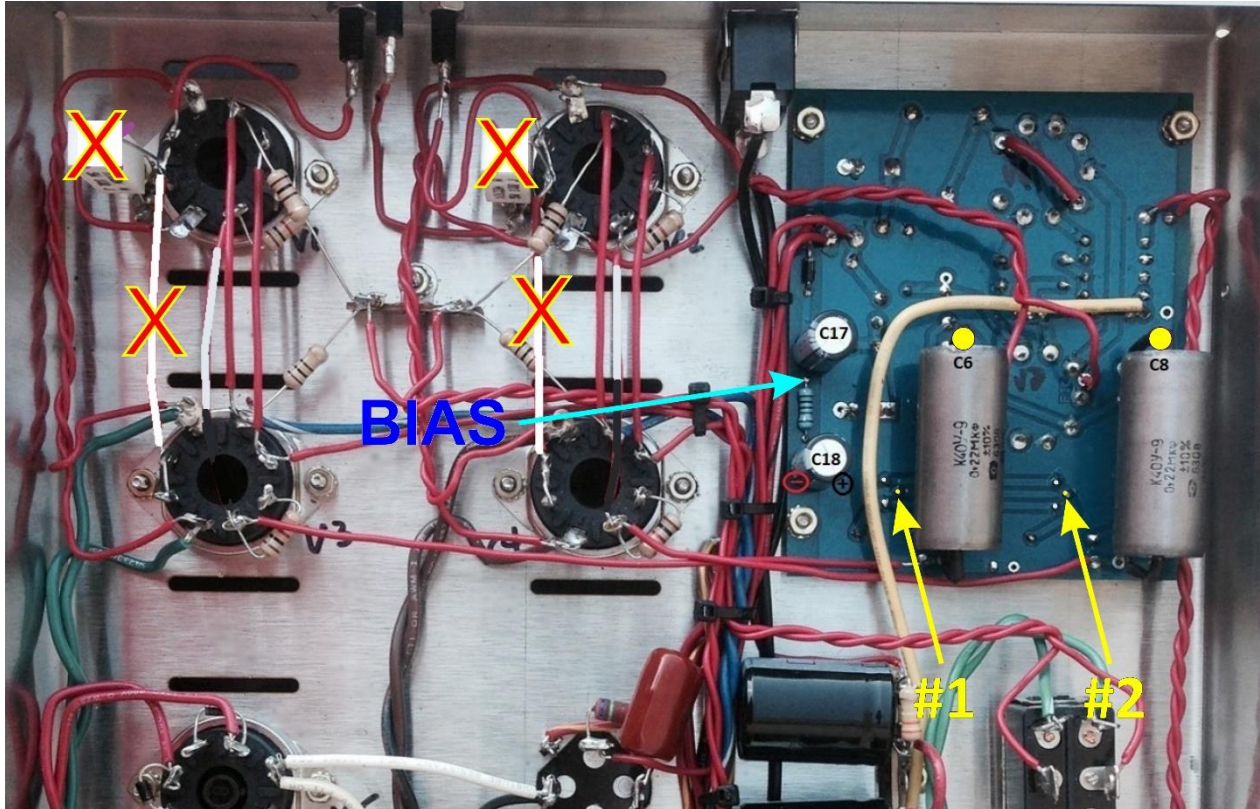

1. Remove the two 10 OHM bias resistors connected to pins 1&8 on the two output tube sockets, marked with a **RED X** on the photo
2. Remove the wires, marked in white on the above photo, between pins 1 of the tube sockets for V1 to V3 and V2 to V4
3. Remove the wires, marked in white on the above photo, between pins 6 of the tube sockets for V1 to V3 and V2 to V4
4. Remove the M-125 driver pcb
5. Remove the two original 50K bias trimmers from the M-125 driver pcb
6. Solder one wire each, about 4" long, into the pcb pad indicated by the two yellow arrows marked #1 & #2. This was the 'wiper' position of the original 50K bias trimmers. Wire marked #1 should be next to R30 on the M-125 driver pcb and the wire marked #2 should be next to R32 on the M-125 driver pcb.
7. Solder one wire each, about 4" long, to one end of the Russian PIO 0.22uF coupling capacitors C6 & C8 on the M-125 driver pcb, marked by a yellow circle on the above photo.
8. Solder one wire to the **+ve** end of C18 on the M-125 driver pcb
9. Solder one wire to the **-ve** end of C18 on the M-125 driver pcb
10. Do not re install the M-125 driver pcb yet!
11. Now refer to the 'Preparing your AB-Q-M125 module for installation' section on the next page

12. If your M125 has the time delay pcb fitted, this must be disconnected. You will need to remove the two red high voltage AC wires and connect them to pins 4 & 6 on the rectifier tube socket! You can leave the green/yellow and brown/yellow wires as well as the wire connected to the GND terminal to the timer module. Disconnect the two 6.3VAC wires from pins 2 & 7 from the V2 socket.

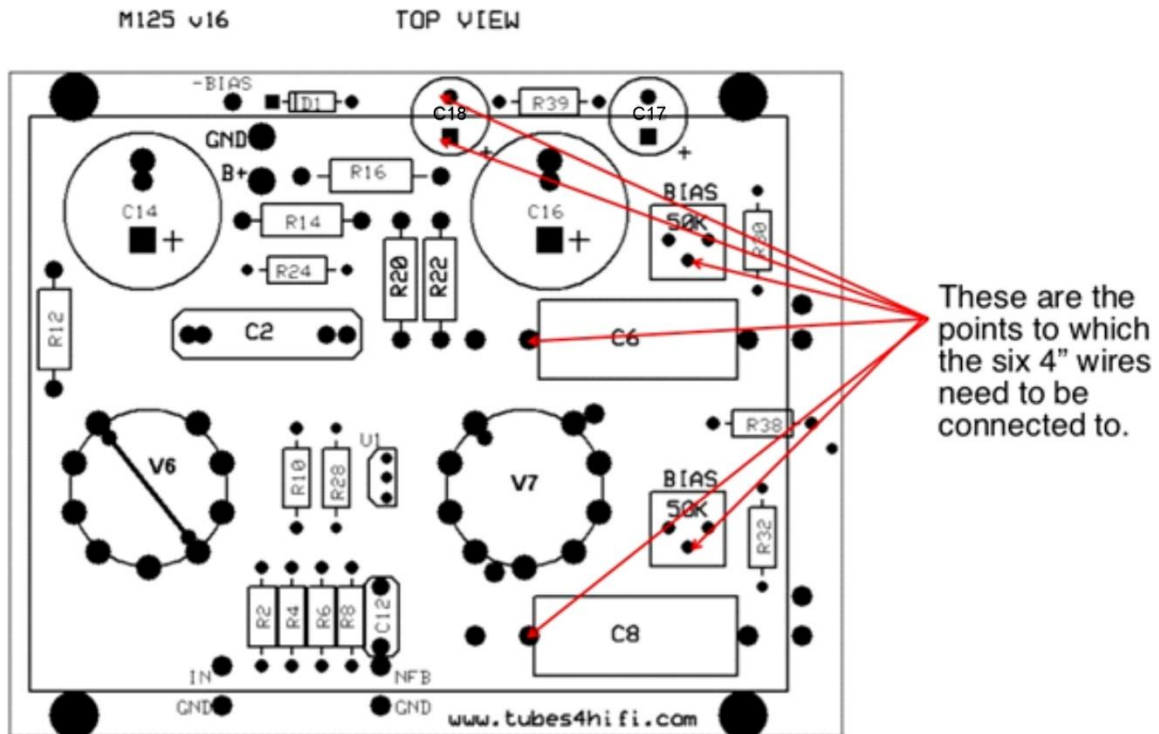

Use the above drawing to orient yourself for the soldering of the six 4" long wires to the M-125 driver pcb.

Preparing your AB-Q-M125 module for installation:

With your AB-Q-M125 module kit you should have also received two 100K 1W resistors, and depending on whether you also ordered the two additional Russian 0.22uF PIO coupling caps. If not, get your own 0.22uF coupling caps ready.

1. Install the two 100K 1W resistors in the R30 and R32 spots on the AB-Q-M125 module respectively
2. Install the supplied Russian PIO, or your own, 0.22uF caps in the C6B and C8B spots on the AB-Q-M125 module respectively

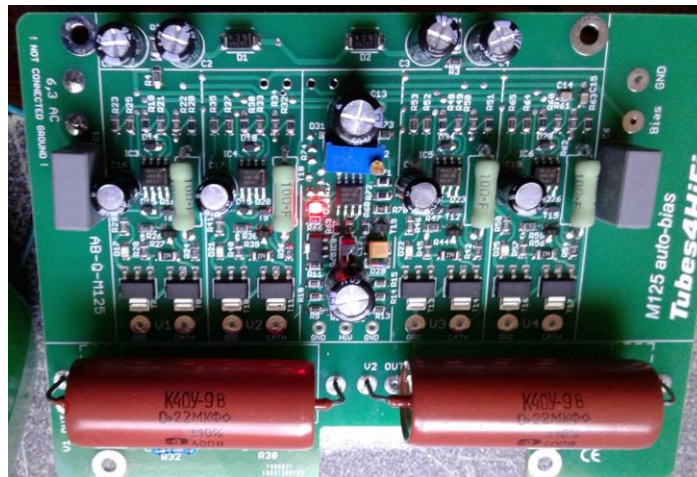
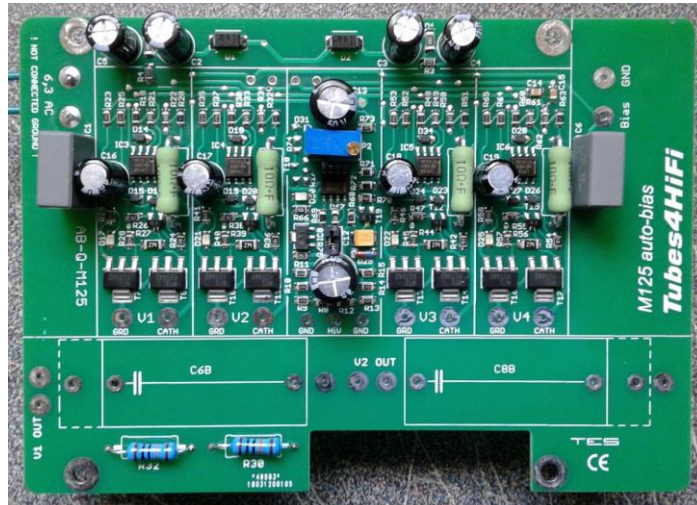

The above photos show the two 100K 1W resistors, R30B & R32B, as well as the two 0.22uF coupling capacitors, C6B and C8B, installed on the AB-Q-M125 module.

Presetting the AB-Q-M125 module bias level:

Before the AB-Q-M125 module can be fully wired up, you need to preset the bias voltage on the AB-Q-M125 module.

For the M125 which KT120 power tubes, we recommend a bias level of 0.6V or 600mV.

For the M125 with KT88 power tubes, we recommend a bias level of 0.5V or 500mV.

This bias level is set using the blue colored trimmer on the AB-Q-M125 module.

We strongly recommend that you preset the AB-Q-M125 module before you proceed with any of the wiring as well as before installing the AB-Q-M125 module in your M125!

We need to connect a 6.3VAC supply to the AB-Q-M125 module for the bias preset. If you have a spare transformer with a 6.3V winding, use that, if not, you will need to 'borrow' 6.3VAC from your M125. If you have a spare transformer, wire it up and connect the 6.3VAC winding to the two **6,3 AC pads** on the AB-Q-M125 module.

If you need to 'borrow' your M125, remove ALL tubes, including the rectifier tube. All we want is the 6.3VAC from the M125, we do not want any B+ high voltage DC!

BE CAREFUL, even though all tubes are removed, there will still be high voltage AC present at the rectifier tube socket!

Solder one wire each, on pin 2 and pin 7 to any power tube socket, V1 to V4, and connect the other end of each wire to the **6,3 AC pads** on your AB-Q-M125 module.

Place your AB-Q-M125 module on a non-conductive surface. Now switch on your M125, or connect the spare transformer, and you should see the **red** LED on the AB-Q-M125 module light up. This LED will go out after about 20s.

Set your meter to read DC and to the lowest scale, say 1V, 2V or 5V. Put the black meter lead on any **GND** pad on the AB-Q-M125 module and put the red meter lead on the pad next to electrolytic capacitor, see below. Now adjust the blue trimmer until the desired bias level is achieved, see above for the different recommended bias levels.

That's it, you just set the AB-Q-M125 module to the desired bias operating level.

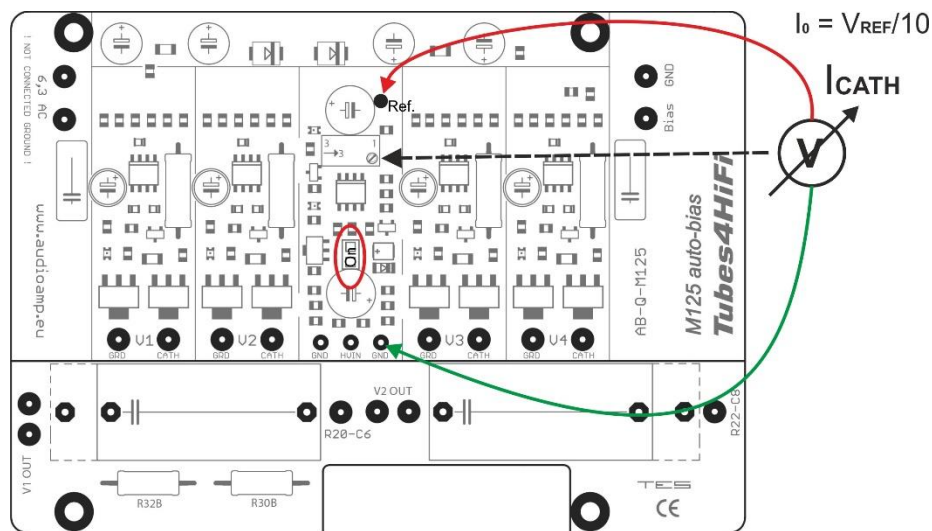

Disconnect the spare transformer or power down your M125, wait for half a minute or so and disconnect the wires from the 6,3 AC pads on the AB-Q-M125 module.

DO NOT EVER readjust the trimmer once the AB-Q-M125 module is installed and wired up. The whole idea of this AB-Q-M125 module is to set in ONCE and forget!

Installing and wiring the AB-Q-M125 module into your M-125:

You will need to solder all the connecting wires to the AB-Q-M125 module. For neatness, solder all the wires on the underside of the AB-Q-M125 module. Make each of these wires about 7" long.

Of course, if you prefer to reinstall both the M-125 driver pcb and the AB-Q-M125 module at this stage, all the wires would need to be soldered to the top of the AB-Q-M125 module. This is entirely your choice.

1. Solder a 7" long wire to each of the following AB-Q-M125 module solder pads: V1 OUT, V2 OUT, V1 CATH, V2 CATH, V3 CATH, V4 CATH and the two pads marked 6,3 AC.
2. DO NOT connect any wires to pads BIAS, GND, V3 GRD, V4 GRD, R20-C6 and R22-C8 as yet, this is done below!
3. The wires in the two 6,3 AC pads should now be tightly twisted, as these are the 6.3VAC supply wires for the AB-Q-M125 module and being AC, have to be twisted to ensure hum free operation!

Before re installing the M-125 driver pcb and the AB-Q-M125 module, you need to connect the six 4" wires previously soldered to the M-125 driver pcb.

This procedure can be a bit of a handful in trying to keep all the pre-soldered wires in check, but do the best you can ☺. Trim each wire to the desired length.

4. Connect the wire marked by the yellow arrow #1, next to R30 on the M-125 driver pcb, to the **V3 GRD** pad on the AB-Q-M125 module, shown as a violet wire in the below wiring diagram
5. Connect the wire marked by the yellow arrow #2, next to R32 on the M-125 driver pcb, to the **V4 GRD** pad on the AB-Q-M125 module, also shown as a violet wire in the below wiring diagram
6. Connect the wire from the end of C6, (see page 3 above for details) on the M-125 driver pcb, to the **R20-C6** pad on the AB-Q-M125 module, shown as a dark blue wire in the below wiring diagram
7. Connect the wire from the end of C8, (see page 3 above for details) on the M-125 driver pcb, to the **R22-C8** pad on the AB-Q-M125 module, also shown as a dark blue wire in the below wiring diagram
8. Connect the wire on the **-ve pin** of C18 on the M-125 driver pcb to the **BIAS** pad on the AB-Q-M125 module, shown as a light blue wire in the below wiring diagram
9. Connect the wire on the **+ve pin** of C18 on the M-125 driver pcb to the **GND** pad on the AB-Q-M125 module, shown as a green wire in the below wiring diagram
10. Connect the two twisted wires from the two 6,3 AC pads on the AB-Q-M125 module to pins **2 & 7** respectively on the power tube socket for **V2**, also shown as the two yellow wires in the below wiring diagram. Route these AC wires neatly along the chassis wall and away from any DC or signal wires.

The AB-Q-M125 module kit also came with new spacers and screws. Use these to now re installed your M-125 driver pcb as well as the AB-Q-M125 module.

Once the AB-Q-M125 module is installed, you can start wiring to the tubes.

11. Connect the wire from the V1 OUT pad on the AB-Q-M125 module to **pin 6** in the **V1** socket, shown as a purple wire in the below wiring diagram
12. Connect the wire from the V2 OUT pad on the AB-Q-M125 module to **pin 6** in the **V2** socket, also shown as a purple wire in the below wiring diagram
13. Connect the wire from the V1 CATH pad on the AB-Q-M125 module to **pin 1&8** in the **V1** socket, shown as a red wire in the below wiring diagram
14. Connect the wire from the V2 CATH pad on the AB-Q-M125 module to **pin 1&8** in the **V2** socket, also shown as a red wire in the below wiring diagram
15. Connect the wire from the V3 CATH pad on the AB-Q-M125 module to **pin 1&8** in the **V3** socket, also shown as a red wire in the below wiring diagram
16. Connect the wire from the V4 CATH pad on the AB-Q-M125 module to **pin 1&8** in the **V4** socket, also shown as a red wire in the below wiring diagram

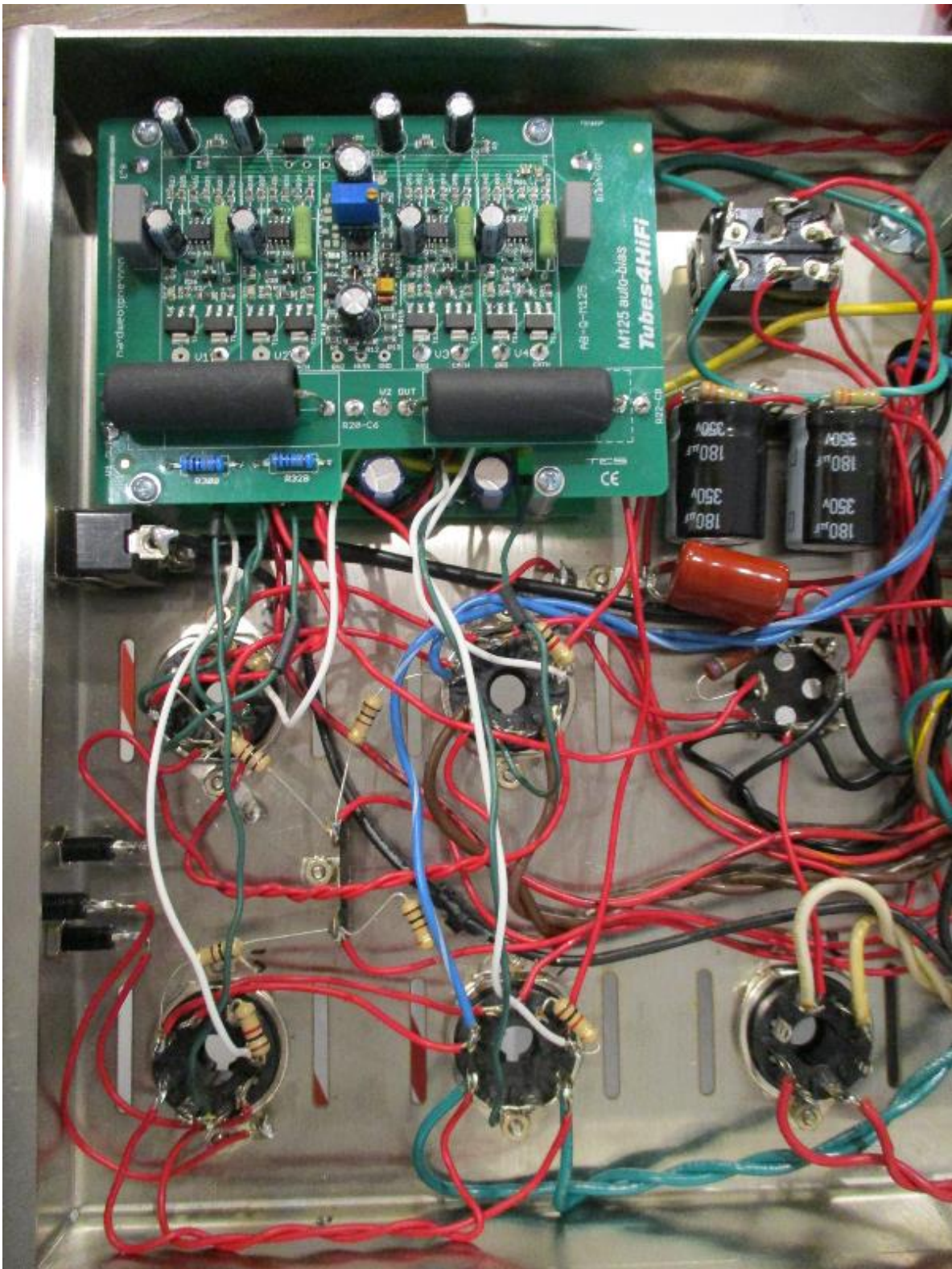

This shows the AB-Q-M125 module installed above the M-125 driver pcb using the supplied spacers and screws and wired up. Keep all of the above wires neat and tidy, maybe use zip ties to group them.

This now pretty much completes the wiring of the AB-Q-M125 module to the M-125 driver pcb and the power tubes. Double check all the wiring steps again, even triple check them ☺

Once you are confident that all your wiring is correct and as per the above steps, it is time to test your AB-Q-M125 module installation. We are assuming that you have installed the AB-Q-M125 module into a known working M125, not a brand new M125 kit build, as you would need to carry out a different sequence of testing your M125 before you should power up the AB-Q-M125 module.

Plug in all tubes, that is the driver tubes, power tubes and the tube rectifier. In order to see the blue LED's on the AB-Q-M125 module, put your M125 on its side.

Maybe stick a piece of styrofoam under one of the transformers to cradle the M125 chassis so that the tubes do not touch the bench top.

Connect an 8 OHM dummy load of at least 100W capacity or your speaker and if you can, short the input using a dummy RCA plug.

Power up your amp. The red LED on the AB-Q-M125 module should come on straight away and will go out after about 20s.

After an additional 40 to 50s, each of the blue LED's on the AB-Q-M125 module should start to come on, which indicates that each output tube has reached the preset bias level and all is good. Excellent!

You can measure the actual bias voltage on each output tube with a meter just to double check.

Set your volt meter to the 1V, 2V or 5V scale in DC volts. Put the red meter lead on pin 1/8 on a power tube socket, V1 to V4 and place the black meter lead to the chassis star ground tag. The meter should read close to 0.5V/500mV if KT120's are used or 0.425V/425mV if KT88's are used. This reading might be a little higher to start with and will get close to or exactly to the preset bias voltage as the output tubes warm up.

Do this measurement for each output tube, V1 to V4, measuring at pins 1/8.

Leave the amp running for about 10 minutes, all four of the blue LED's should remain lit.

Power down the amp and let everything cool down a bit then put the bottom chassis cover back on.

Remove the dummy RCA plug.

Place your M125 amps in their spot, connect your speakers, RCA input and power lead to each M125 and power the amps back up. After about a minute or so, the amps are ready for your listening session!

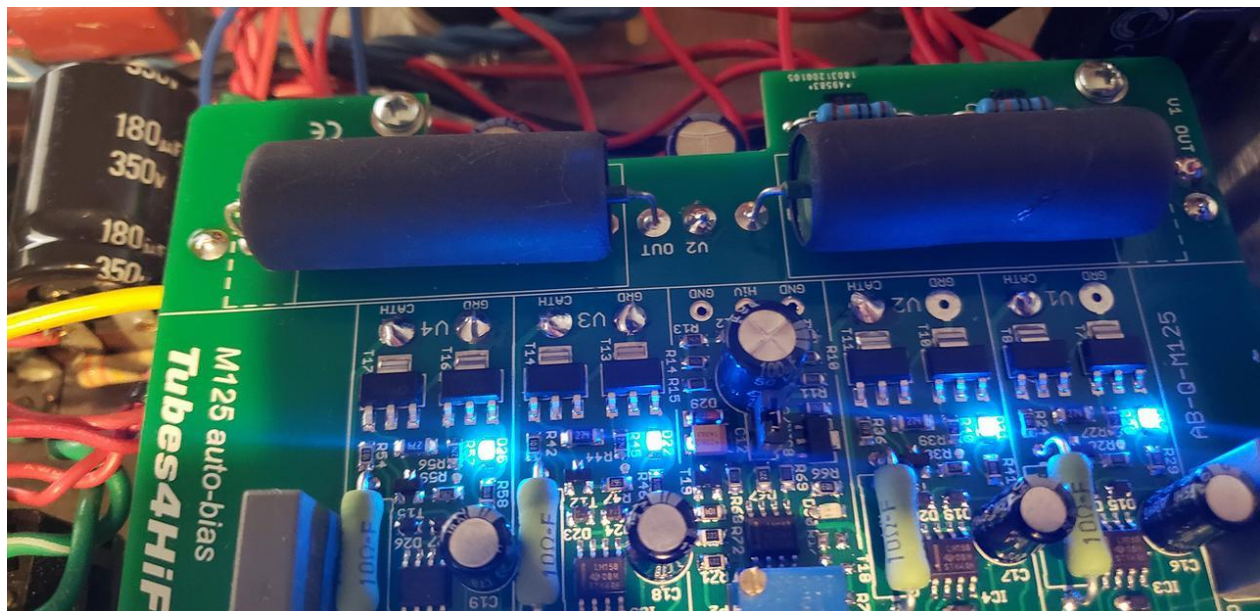

If things do not work as they are supposed to:

If the **red** LED on the AB-Q-M125 module does not come on immediately after the amp is powered up, power it back down and check the wiring/connections from pins 2 & 7 on the V2 socket to the two 6,3 AC pads on the AB-Q-M125 module. Make sure all is good there!

If none of the **blue** LED's come on after the 40-50s soft start delay, power the amp back down. Check all your wiring from the AB-Q-M125 module to each of the output tube pins and to the M-125 driver pcb.

If say only three or two of the **blue** LED's come on after the soft start delay, power the amp back down and check the wiring to that particular tube for which the **blue** LED did not go on for. Also check to make sure that the pins in that tube socket are nice and tight and that the tube fits into the socket not at all loose. Also check the pins in the tube socket of any oxidization, if they are dirty, perhaps use Deoxit or similar to clean the pins!

Do's and don'ts:

Do check that the pins in each tube socket are tight and that each tube does not fit loosely in the socket. Do check that the pins in each tube socket are clean of oxidization, use Deoxit or similar if they are not clean.

Good fitting and clean pins in tube sockets make ALL the difference!!

Don't do a lot of tube rolling! This is a sure way to loosen up the pins in your sockets! If you cannot help yourself and you must do tube rolling, check the tightness of the pins each time you swap tubes!